

## Data sheet | Item number: 769-644/003-000

THT male header; 1.0 x 1.0 mm solder pin; straight; clamping collar; Pin spacing 5 mm; 14-pole; gray

[www.wago.com/769-644\\_003-000](http://www.wago.com/769-644_003-000)

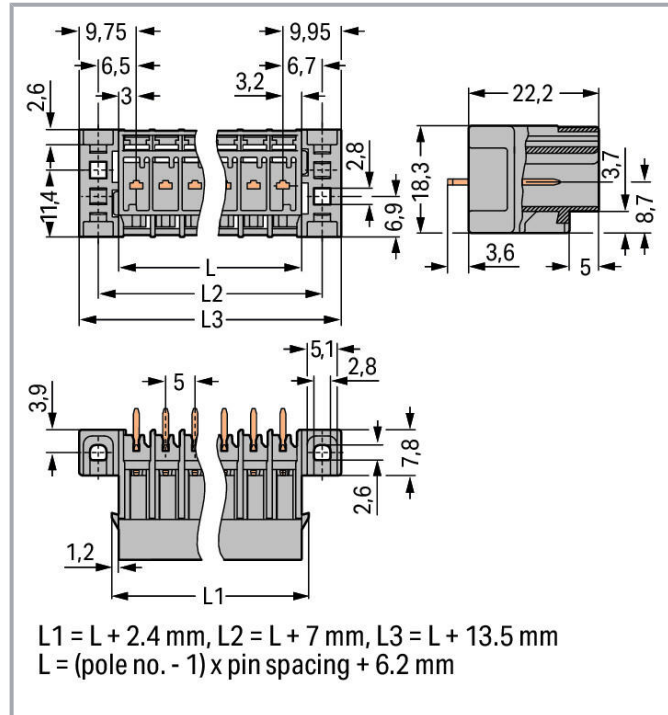
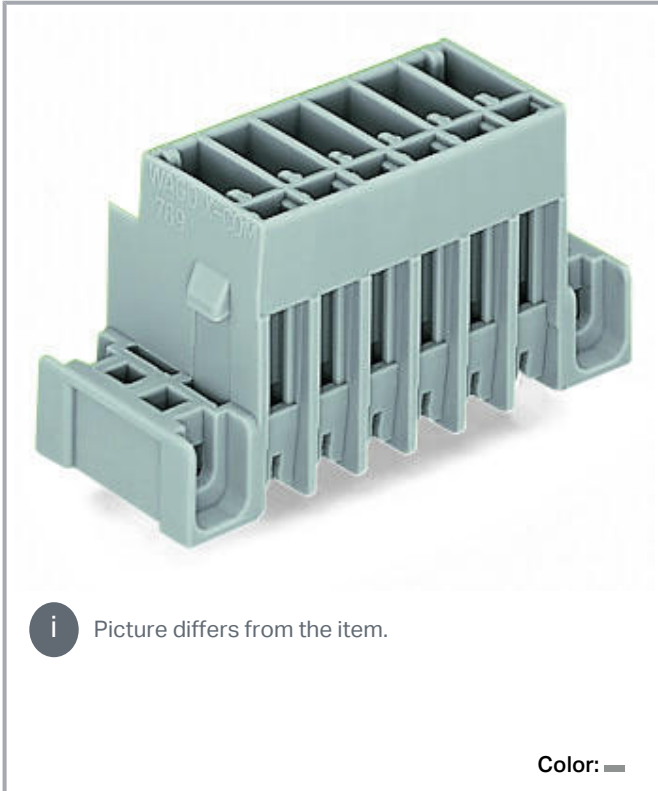

### Data

#### Electrical data

#### IEC Approvals

Rated voltage (III / 3)	250 V
Rated surge voltage (III/3)	4 kV
Rated voltage (III/2)	500 V
Rated surge voltage (III/2)	4 kV
Rated current	32 A
Legend (ratings)	(III / 3) $\hat{=}$ Overvoltage category III / Pollution degree 3

Subject to changes. Please also observe the further product documentation!

WAGO Corporation  
Germantown, WI 53022  
Phone: 1-800-DIN-RAIL (346-7245) | Fax: (262) 255-6222  
Email: [info.us@wago.com](mailto:info.us@wago.com) | Web: [www.wago.us](http://www.wago.us)

Do you have any questions about our products?  
We are always happy to take your call at (262) 255-6222 or 1 800-DIN-RAIL.



## Connection data

Pole No.	14
Total number of potentials	14
Number of levels	1
Preceding contacts	0

## Physical data

Pin spacing	5 mm / 0.197 inch
Width	84.7 mm / 3.335 inch
Height from the surface	22.2 mm / 0.874 inch
Depth	18.3 mm / 0.72 inch

## Mechanical data

Mounting type	Mounting flange
---------------	-----------------

## Plug-in connection

Contact type (pluggable connector)	Male header
Connector (connection type)	for PCB
Mismating protection	No
Mating direction to the PCB	90°

## PCB contact

PCB Contact	THT
-------------	-----

## Material data

Color	gray
Insulation material	Polyamide (PA66)
Flammability class per UL94	V0
Fire load	0.309 MJ
Weight	14.5 g

## Commercial data

Product Group	18 (X-COM-System)
Packaging type	BOX

Subject to changes. Please also observe the further product documentation!





WAGO Corporation  
Germantown, WI 53022  
Phone: 1-800-DIN-RAIL (346-7245) | Fax: (262) 255-6222  
Email: [info.us@wago.com](mailto:info.us@wago.com) | Web: [www.wago.us](http://www.wago.us)

Do you have any questions about our products?  
We are always happy to take your call at (262) 255-6222 or 1 800-DIN-RAIL.

Country of origin	PL
GTIN	4017332412988
Customs tariff number	8536694040

## Approvals / Certificates

### Country specific Approvals

Logo	Approval	Additional Approval Text	Certificate name
	CCA DEKRA Certification B.V.	EN 60947	NTR NL-7626
	CCA DEKRA Certification B.V.	EN 61984	2190419.02
	CCA DEKRA Certification B.V.	IEC 61984	NL-47799 /A1
	CSA DEKRA Certification B.V.	C22.2 No. 158	1101144
	KEMA/KEUR DEKRA Certification B.V.	EN 60947	2190419.01

### Ship Approvals

Logo	Approval	Additional Approval Text	Certificate name
	DNV GL Det Norske Veritas, Germanischer Lloyd	-	TAE00001V2

### UL-Approvals

Logo	Approval	Additional Approval Text	Certificate name
	UR Underwriters Laboratories Inc.	UL 1977	20151210-E45171
	UR	UL 1059	20190731-

Subject to changes. Please also observe the further product documentation!



## Optional accessories

### Coding

	<b>Item no.: 769-435</b> Coding pin; for coding of female plugs; for carrier terminal blocks / male connectors; orange	<a href="http://www.wago.com/769-435">www.wago.com/769-435</a>
---	---	--

### Marking accessories

	<b>Item no.: 210-831</b> Marking strips; on reel; 2.3 mm wide; plain; Self-adhesive; white	<a href="http://www.wago.com/210-831">www.wago.com/210-831</a>
	<b>Item no.: 210-832</b> Marking strips; on reel; 3 mm wide; plain; Self-adhesive; white	<a href="http://www.wago.com/210-832">www.wago.com/210-832</a>
	<b>Item no.: 210-833</b> Marking strips; on reel; 6 mm wide; plain; Self-adhesive; white	<a href="http://www.wago.com/210-833">www.wago.com/210-833</a>
	<b>Item no.: 210-834</b> Marking strips; on reel; 5 mm wide; plain; Self-adhesive; white	<a href="http://www.wago.com/210-834">www.wago.com/210-834</a>

## Downloads

### Documentation

#### Bid Text

769-644/003-000 X81 - Datei	Feb 19, 2019	xml 3.1 kB	Download
769-644/003-000 doc - Datei	Oct 4, 2017	doc 25.6 kB	Download

#### Additional Information

Technical explanations	Apr 3, 2019	pdf 2.2 MB	Download
------------------------	-------------	---------------	----------

## CAD files

### CAD data

2D/3D Models 769-644/003-000		URL	Download
------------------------------	--	-----	----------

Subject to changes. Please also observe the further product documentation!



## PCB Design

Symbol and Footprint 769-644/003-000

[URL](#)

[Download](#)

CAx data for your PCB design, consisting of "schematic symbols and PCB footprints", allow easy integration of the WAGO component into your development environment.

### Supported formats:

- Accel EDA 14 & 15
- Altium 6 to current version
- Cadence Allegro
- DesignSpark
- Eagle Libraries
- KiCad
- Mentor Graphics BoardStation
- Mentor Graphics Design Architect
- Mentor Graphics Design Expedition 99 and 2000
- OrCAD 9.X PCB and Capture
- PADS PowerPCB 3, 3.5, 4.X, and 5.X
- PADS PowerPCB and PowerLogic 3.0
- PCAD 2000, 2001, 2002, 2004, and 2006
- Pulsonix 8.5 or newer
- STL
- 3D STEP
- TARGET 3001!
- View Logic ViewDraw
- Quadcept
- Zuken CadStar 3 and 4
- Zuken CR-5000 and CR-8000

PCB Component Libraries (EDA), PCB CAD Library Ultra Librarian

---

## CAE data

ZUKEN Portal 769-644/003-000

[URL](#)

[Download](#)

---

## Environmental Product Compliance

### Compliance Search

Environmental Product Compliance 769-644/003-000

Subject to changes. Please also observe the further product documentation!

---

WAGO Corporation  
Germantown, WI 53022  
Phone: 1-800-DIN-RAIL (346-7245) | Fax: (262) 255-6222  
Email: [info.us@wago.com](mailto:info.us@wago.com) | Web: [www.wago.us](http://www.wago.us)

Do you have any questions about our products?  
We are always happy to take your call at (262) 255-6222 or 1 800-DIN-RAIL.

THT male header; 1.0 x 1.0 mm solder pin; straight; clamping collar; Pin spacing 5 mm;  
14-pole; gray

## Installation Notes

### Application

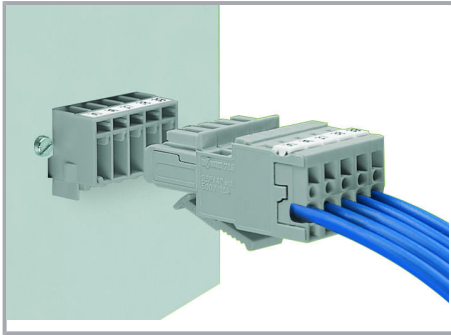

Male header with mounting flanges

1-conductor female plug with bottom-mount locking levers

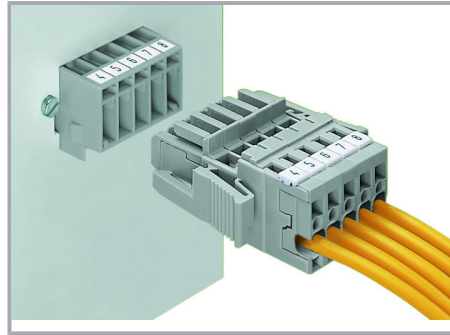

Male header with mounting flanges

1-conductor female plug with lateral locking levers

## Product family

### X-COM

[Show all products from the family](#)

Subject to changes. Please also observe the further product documentation!

WAGO Corporation  
Germantown, WI 53022  
Phone: 1-800-DIN-RAIL (346-7245) | Fax: (262) 255-6222  
Email: [info.us@wago.com](mailto:info.us@wago.com) | Web: [www.wago.us](http://www.wago.us)

Do you have any questions about our products?  
We are always happy to take your call at (262) 255-6222 or 1 800-DIN-RAIL.